

PROLON



QUICK START **GUIDE**

BLUETOOTH, NETWORK CONTROLLER AND DIGITAL THERMOSTAT

www.proloncontrols.com | info@proloncontrols.com

17 510 rue Charles, Suite 100, Mirabel, QC, J7J 1X9

REV 2.0
PL-QCK-MIX-EN

© Copyright 2019 Prolon. All rights reserved.

No part of this document may be photocopied or reproduced by any means, or translated to another language without prior written consent of Prolon. All specifications are nominal and may change as design improvements are introduced. Prolon shall not be liable for damages resulting from misapplication or misuse of its products. All trademarks are the property of their respective owners.

Table of Contents

Bluetooth (PL-485-BT)	4
System Requirements	4
Minimum operating system for Bluetooth	4
Package Contents	4
Installing Prolon Focus Application	4
Connecting Using Bluetooth 4.0 LE	4
Connecting Over USB (Windows Only)	5
Power & Charging	5
Connecting the RS485 Side	5
Battery Precautions	6
Regulatory and Safety Notices	7
Network Controller (PL-NC2000)	10
Digital Thermostat (PL-T1100)	12
Installation	12
Inputs / Outputs	14
Operation	14
Changing the setpoint	15
Schedule Override	15
Compliance	16
Technical Specifications	16

Bluetooth (PL-485-BT)

System Requirements

The PL-485-BT can be used from various platforms, but in all cases, the following is required:

- Prolon Focus Application (free - see below for details)
- Bluetooth 4.0 LE capable device (integrated or via dongle)

Minimum operating system for Bluetooth

- iOS: Version 9.0
- Android: Android 4.3 (Jelly Bean)
- Support for Windows & macOS coming soon

Package Contents

- PL-485-BT Converter
- USB Cable
- CAT5 Cable

Installing Prolon Focus Application

Obtain the free Prolon Focus App from the appropriate source:

- Windows: Prolon's website: www.proloncontrols.com
- iOS: Apple App Store (Search for Prolon Focus)
- Android: Google Play Store (Search for Prolon Focus)

Connecting Using Bluetooth 4.0 LE

To communicate to the PL-485-BT over Bluetooth, you must first pair it with your device. The pairing process varies with the device you are using. Please view the Hardware Guide at www.proloncontrols.com for more details. The default pairing code is "**000000**".

Connecting Over USB *(Windows Only)*

The PL-485-BT requires drivers on the computer for it to function. The drivers are included along with the ProLon Focus Application. If your computer still cannot locate the drivers, please direct it to manually search in the ProLon installation folder, in the 'Drivers' subfolder.

Power & Charging

The PL-485-BT is equipped with a rechargeable Lithium-Ion battery. It charges via the USB port. It is also equipped with an ON/OFF button. The switch must be in the ON position for the converter to operate as a communications device (Bluetooth or USB). When the converter is not being used, switch to the OFF position to conserve battery life. The converter's battery can still be charged even when the switch is in the OFF position.

Upon Power-Up, the POWER LED will be ORANGE for a brief period of time (approx. 45 sec) while the battery level is being calculated internally. After this period, the POWER LED will be:

- Blinking **RED** when USB unplugged
- Solid **RED** when USB plugged and charging
- Solid **GREEN** when USB plugged and the battery has been fully charged

Connecting the RS485 Side

Connect the A (+) and B (-) screw terminals to the wires of appropriate polarity on the RS485 bus, using appropriate RS485 cabling. Connect the GND screw terminal to RS485 GND reference as needed.

Alternatively, the PL-485-BT is equipped with an RJ45 jack that carries the same RS485 A (+), B (-) and GND signals among the eight pins within the jack (see Figure below for pinout). This port is very practi-

Bluetooth (PL-485-BT)

cal since it can be used to quickly connect to ProLon controllers that are equipped with a similar RJ45 jack using a standard CAT5 cable (included). This approach saves time since there is no need to cut and strip wires.

Note: The RJ45 jack is NOT an ETHERNET port. The PL-485-BT does NOT SUPPORT ETHERNET.

The RS485 TXD and RXD LEDs blink briefly as bytes are being transmitted or received respectively over the RS485 line, but do not indicate the validity or comprehension of these bytes by the equipment.

The RS485 circuitry in the PL-485-BT is electrically isolated from the USB circuitry, thereby avoiding any potentially hazardous GND loops with your PC.

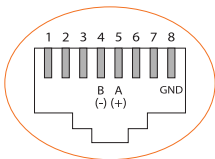

Battery Precautions

- Do not attempt to replace the battery. It is built-in and not changeable.
- Charge your converter using a certified computer, powered hub or power supply.
- Charge the battery in accordance with the instructions supplied with this guide.
- Use only the charger cable that shipped with your product to charge the battery.

Regulatory and Safety Notices

Model Name: PL-485-BT

USA: Federal Communications Commission (FCC) Statement

This device complies with part 15 of the FCC Rules.

Operation is subject to the following two conditions:

1. This device may not cause harmful interference and
2. This device must accept any interference, including interference that may cause undesired operation of the device.

FCC Warning:

Changes or modifications not expressly approved by Prolon Inc. could void the user's authority to operate the equipment.

Note: This equipment has been tested and found to comply with the limits for a Class B digital device, pursuant to part 15 of the FCC Rules. These limits are designed to provide reasonable protection against harmful interference in a residential installation. This equipment generates uses and can radiate radio frequency energy and, if not installed and used in accordance with the instructions, may cause harmful interference to radio communications. However, there is no guarantee that interference will not occur in a particular installation. If this equipment does cause harmful interference to radio or television reception, which can be determined by turning the equipment off and on, the user is encouraged to try to correct the interference by one or more of the following measures:

- Reorient or relocate the receiving antenna.
- Increase the separation between the equipment and receiver.
- Connect the equipment into an outlet on a circuit different from that to which the receiver is connected.

Bluetooth (PL-485-BT)

- Consult the dealer or an experienced radio/TV technician for help.

To comply with FCC/IC RF exposure limits for general population / uncontrolled exposure, the antenna(s) used for this transmitter must be installed to provide a separation distance of at least 20 cm from all persons and must not be co-located or operating in conjunction with any other antenna or transmitter.

FCC ID: 2AK90-485BT20

Canada: Industry Canada (IC) Statement

IC Notice to Users English/French in accordance with RSS GEN Issue 3:

This device complies with Industry Canada license-exempt RSS standard(s). Operation is subject to the following two conditions:

1. This device may not cause interference, and
2. This device must accept any interference, including interference that may cause undesired operation of the device.

Le présent appareil est conforme aux CNR d'Industrie Canada applicables aux appareils radio exempts de licence. L'exploitation est autorisée aux deux conditions suivantes:

1. l'appareil ne doit pas produire de brouillage, et
2. l'utilisateur de l'appareil doit accepter tout brouillage radioélectrique subi, même si le brouillage est susceptible d'en compromettre le fonctionnement.

IC Radiation Exposure Statement:

This equipment complies with IC RSS-102 radiation exposure limit set forth for an uncontrolled environment. This equipment should be installed and operated with minimum distance 20cm between the radiator and your body.

Déclaration d'exposition à la radiation:

Cet équipement respecte les limites d'exposition aux rayonnements IC définies pour un environnement non contrôlé. Cet équipement doit être installé et mis en marche à une distance minimale de 20 cm qui sépare l'élément rayonnant de votre corps.

L'émetteur ne doit ni être utilisé avec une autre antenne ou un autre émetteur ni se trouver à leur proximité.

CAN ICES-3 (B)/NMB-3(B)

IC : 22455-485BT20

Network Controller (PL-NC2000)

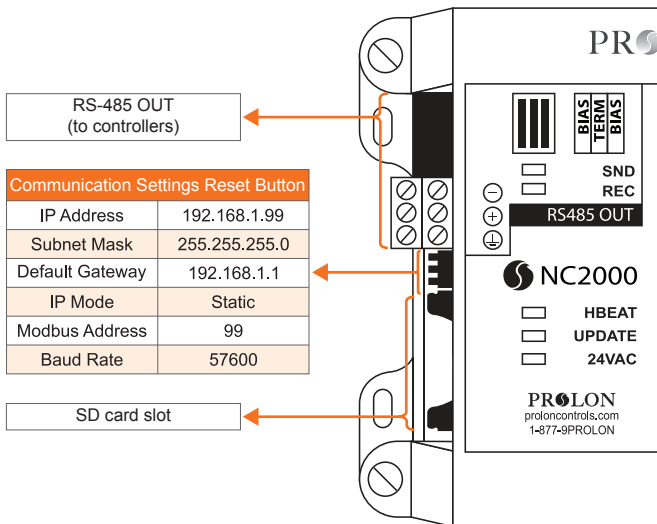

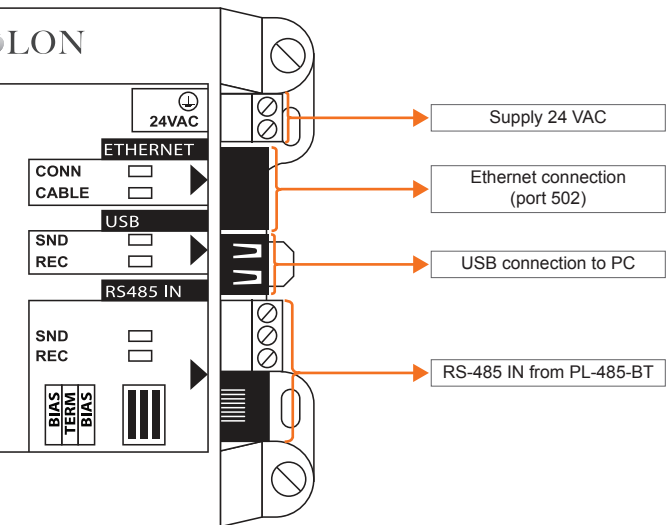

Default Modbus address	Default net settings
99	DHCP

Digital Thermostat (PL-T1100)

Installation

1. Open casing to remove back cover by pushing on the tab located underneath the thermostat. (See Figure 1)
2. Pull wire(s) through central hole of back cover.
3. Screw in the back cover to the wall.
4. Connect wires:
 - If using twisted pair wires:
 - Pull out screw terminal block.
 - Remove 1 cm insulation from each wire.
 - Connect the wires to the terminal blocks and reconnect the terminal blocks. (See Figure 2)
 - If using CAT5 cable:
 - Plug the cable into the RJ45 jack of the T1100 (if CAT5 cable is opened at the controller, refer to Figure 3 for pinout of the T1100's RJ45 jack).
5. Reconnect top cover.

IMPORTANT! Do not install the thermostat under the following conditions:

- Any location exposed to direct sunlight.
- On an outside wall.
- Near an air discharge grill.
- In a location where vertical air circulation is restricted.
- Near a dimmer switch.

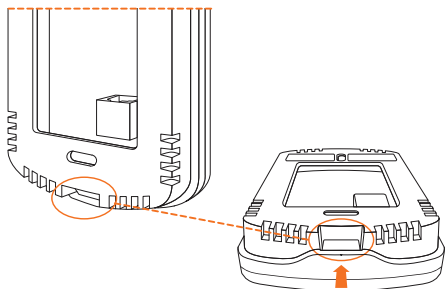

Figure 1

□	⊘	1	NET A
□	⊘	2	NET B
□	⊘	3	24 VAC
□	⊘	4	COM

Figure 2

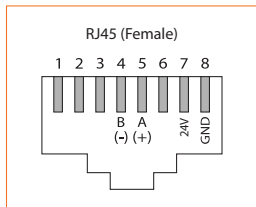

Figure 3

Digital Thermostat (PL-T1100)

Inputs / Outputs



Digital Output (triac dry contact)



Analog Output (0-10VDC)

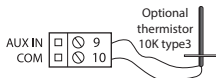

Analog Input

Operation

The T1100 is controlled using the circular touch pad on the bottom half of the thermostat. The touch pad uses capacitive sensing technology to detect finger proximity. There are no moving parts to push or rotate. The T1100 is controlled using simple scrolling, tapping or holding motions, performed around the circle of the touch pad. The center of the circle is unused.

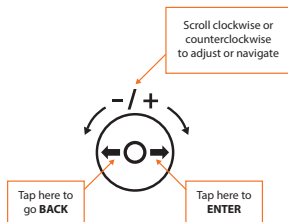

Changing the setpoint

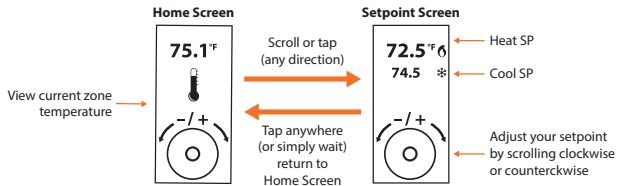

Schedule Override

The first, go to the setpoint screen.

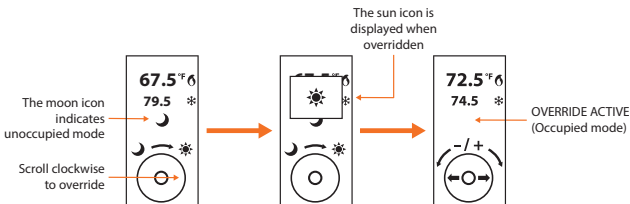

Compliance

PLEASE NOTE, for the PL-485-BT see page 7.

Network Controller (PL-NC2000)

- cULus Listed; UL 916 Energy Management Equipment, File E364757, Vol.1
- CAN/CSA-C22.2 No. 2015-12, Signal Equipment
- FCC Compliant to CFR47, Part 15, Subpart B, Class B
- Industry Canada (IC) Compliant to ICES-003, Issue 5: CAN ICES-3 (B)/NMB-3(B)
- RoHS Directive (2002/95/EC)

Digital Thermostat (PL-T1100)

- FCC Compliant to CFR47, Part 15, Subpart B, Class B
- Industry Canada (IC) Compliant to ICES-003, Issue 5: CAN ICES-3 (B)/NMB-3(B)
- RoHS Directive (2002/95/EC)

FCC User Information

This device complies with Part 15 of the FCC Rules. Operation is subject to the following two conditions: (1) this device may not cause harmful interference, and (2) this device must accept any interference received, including interference that may cause undesired operation.

Industry Canada

This Class (B) digital apparatus meets all the requirements of the Canadian Interference-Causing Equipment regulations.

Cet appareil numérique de la Classe (B) respecte toutes les exigences du Règlement sur le matériel brouilleur du Canada.

Technical Specifications

Network Controller (PL-NC2000)

Supply: 24 VAC \pm 10%, 50/60 Hz, Class 2

Consumption: 5 VA max

Digital Thermostat (PL-T1100)

Supply: 24 VAC \pm 10%, 50/60 Hz

Consumption: 5 VA (typ), 13 VA (max)