

NETWORK GUIDE



REV. 5.4

***PROLON
INTELLIGENT ZONE
CONTROL SYSTEM***

***MODBUS RS485
NETWORK GUIDE***

info@prolon.net

www.prolon.net

PROLON

1-877-9PROLON

Montréal

1989 rue Michel Laval,
QC H7L 5B7
TEL: (450) 973-7765 FAX: (450) 973-6186
1-800-461-1381

Table of Contents

Creating a VC1000 Network.....	3
Topology	3
Unit Addressing.....	4
Terminating Resistors	5
Shielding	5
Interconnecting the common	6
Bias Resistors.....	6
VC1000 Hardware Configuration.....	7
Network Properties of a ProLon Master	8
Updating the Master's slave list.....	8
Master-Slave data transaction.....	9
Positioning the Master on a network	10
Typical Network Configurations.....	11
Configuration 1: RS485 Direct connection to multiple slaves.....	11
Configuration 2: Internet connection to multiple slaves.....	12
Configuration 3: Modem connection to multiple slaves.....	13
Configuration 4: RS485 Direct connection with a single Master and multiple slaves	14
Configuration 5: Internet connection with a single Master and multiple slaves	16
Configuration 6: Modem connection with a single Master and multiple slaves.....	18
Configuration 7: RS485 Direct connection with multiple Masters and multiple slaves.....	20
Network Components	22
PL-485.....	22
PL-NC-SCHED	23
MODEM.....	24
PL-BR2.....	26

Creating a VC1000 Network

The following document gives an in-depth look at the procedures required to get the ProLon VC1000 network working properly. NOTE: A ProLon VC1000 network uses the Modbus RTU protocol. This protocol requires a master/slave architecture where only a single master is allowed per network.

Topology

A VC1000 network must use a bus topology (daisy chain). A bus topology is the physical routing of the communication channel that includes a distinct beginning and end.

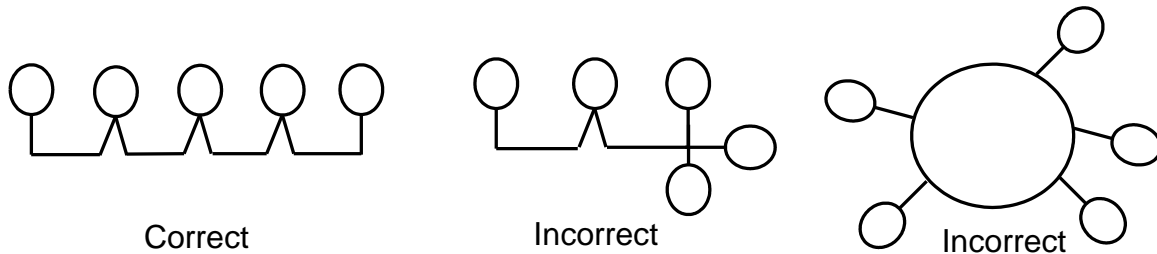

To connect VC1000 devices in a bus topology, the NET A port of one VC1000 device must be connected to the NET A port of the VC1000 devices directly preceding it and following it in the bus. The same must then be done with the NET B wires. If the NET wires are mistakenly inverted, LED#5 on the VC1000 device will turn ON and it will not be able to communicate. However this will not affect the other VC1000s on the network.

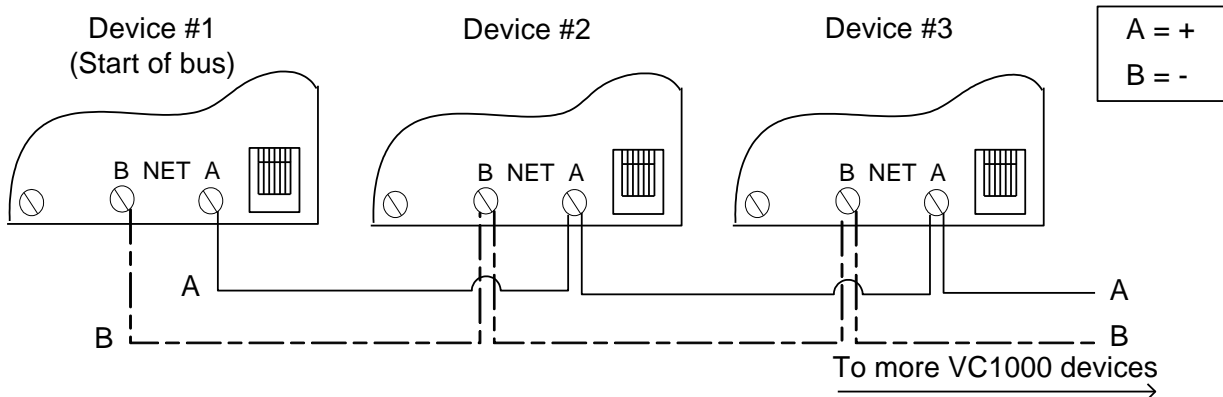

The maximum wire length in a VC1000 network depends on the type of wire used:

- 1000m using 24 AWG PL-MBN cable
- 600m using CAT5 cable

Keep stub length smaller than 20 meters.

Unit Addressing

All VC1000 devices have a dipswitch located on it, which permits addressing of the device. To give a VC1000 device a specific address, move the switches so that their resulting value adds up to the desired address. Make sure all VC1000 devices have different addresses, all greater than zero and all smaller or equal to 127.



Value when ON: 1 2 4 8 16 32 64 N/A

In this example, switches 1, 2, 4 and 6 are ON, so the address of the VC1000 device is

$$1+2+8+32 = 43$$

Terminating Resistors

To ensure proper RS485 communication, terminating resistors are used at both ends of a bus to reduce voltage reflections. To apply this to a VC1000 network, the FIRST and LAST devices on a bus should have their terminating resistors ENABLED, while the others in between should be DISABLED. To facilitate this procedure, each VC1000 device has terminating resistors built-in, which can be ENABLED or DISABLED using JUMPERS.

To ENABLE a terminating resistor on a VC1000 device, simply put a jumper between the appropriate pins (See the [VC1000 Hardware Configuration](#) section):

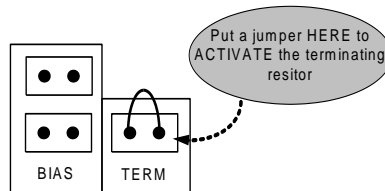

To DISABLE a terminating resistor, remove the appropriate jumper.

NOTE: Since a PL-485-USB or a PL-NC-SCHED always mark the beginning of a bus, they should always have their terminating resistors enabled (see sections [PL-485-USB](#) and [PL-NC-SCHED](#) for details on how to enable terminating resistors on these devices). By default, the terminating resistors of a VC1000 slave are disabled, whereas the Master's are enabled.

Shielding

The cable shielding for each bus must be connected to protective ground at only one point on the bus.

Interconnecting the common

It is recommended that each VC1000 device on the same bus uses the same common. This can be done using two different methods.

Method 1 (Recommended)

Besides NET A and B, connect all VC1000 devices together with a third wire, the common. This common can be connected to the VC1000 at either pins 1, 3, 5, 11 (COM), or 15 (GND). This common must be connected to protective ground, preferably at one point on the bus.

Method 2

Make sure that the casing of each transformer powering the VC1000 devices is connected to protective ground. Then, make sure that the common of the power source is connected to the transformer casing. Note that this method is not as effective as method 1 since power surges or other electrical phenomenon may cause ground loops.

Bias Resistors

Bias resistors are used to keep the network in a known state during times when there are no transmissions. Only ONE node on the bus should have its bias resistors ENABLED. All other nodes should have their bias resistors disabled. If more than one node has its bias resistors enabled, the network may experience signal degradation.

To enable bias resistors on a VC1000 device, simply put a jumper between the appropriate pins (See the [VC1000 Hardware Configuration](#) section):

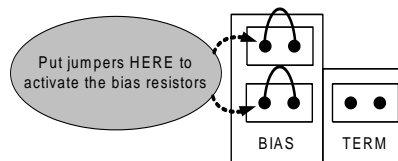

To disable bias resistors on a VC1000, remove BOTH the jumpers from those pins. Upon delivery, bias resistors are disabled for slaves and enabled for Masters.

VC1000 Hardware Configuration

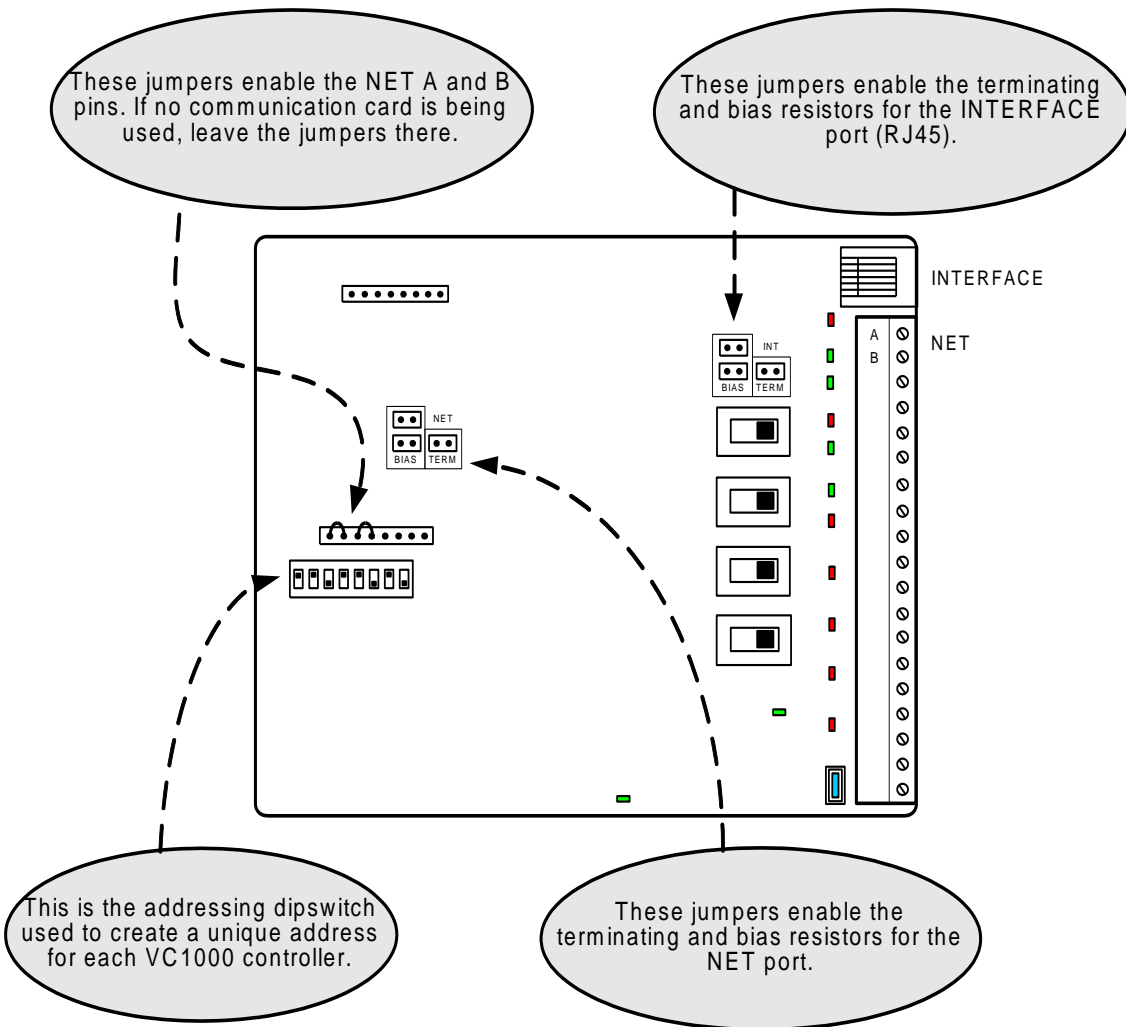

Network Properties of a ProLon Master

The ProLon Master is not only a rooftop or heatpump controller, but is also in charge of the network aspects of the VC1000 system. At all times, the Master keeps a list of all the slaves on his network. It is this list that the master uses to keep track of what the slaves on his network are doing, and to keep the slaves updated as well. The master also uses this list to act as a router, permitting only the messages intended for the slaves on his list to pass. If a slave is behind a master but NOT on the Master's slave list, no outside messages will reach him.

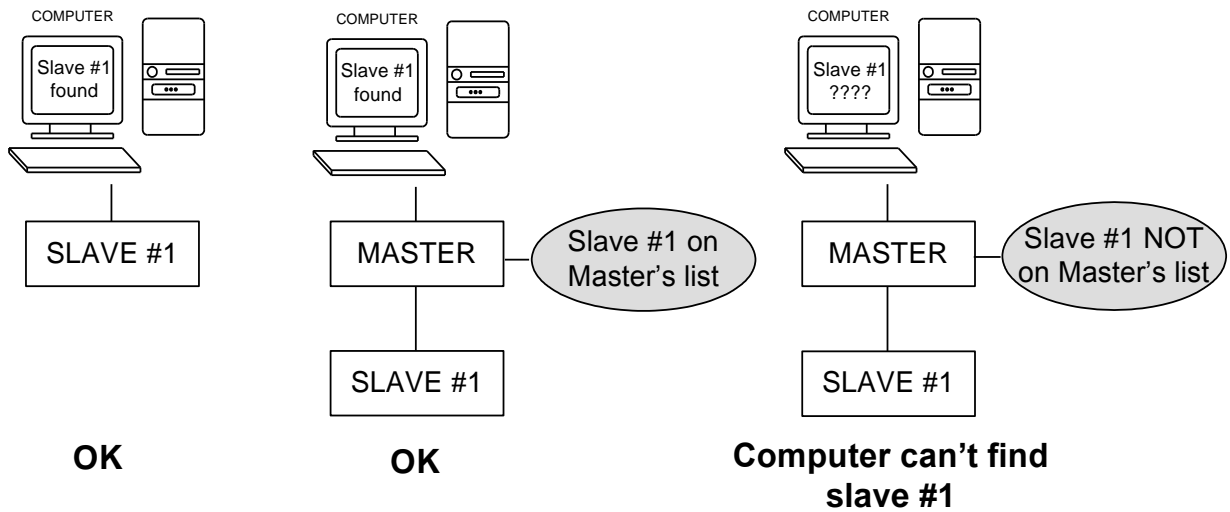

Updating the Master's slave list

Method 1

To update the master's slave list, you can always press the reset button on the master. This causes the master to reinitialize, where it automatically checks the network for all slaves.

Method 2*

Right-click on the Master's icon and select "Get List". The master will check the network and create an icon for all slaves that are found.

Method 3*

Double-click on the Master's icon to open the configuration window. Navigate to the "Slave List" screen and click on the "Check Network" button. The master will retrieve the new slave list.

Method 4*

Double-click on the Master's icon to open the configuration window. Navigate to the "Slave List" screen and use the "Add" or "Remove" buttons to manually add slaves to the list. Press "Apply and Save" button when finished. NOTE: for VC1000s to appear in the network list on the left, you must first create Icons for them in ProLon Focus.

A Master can also be configured to update its list automatically at regular intervals.

(* ProLon Focus is required to use these methods.)

Master-Slave data transaction

At regular intervals the Master exchanges data with all the slaves on his list.

The data that the Master retrieves from each slave:

- Demand, group codes and group weights
- Override status
- Duct temperature (only if this VC1000 is the network duct temperature source. See the Focus User's Guide for more details)

The data that the Master sends to each slaves:

- Network duct temperature
- Occupancy status
- The result of the 5 math functions
- Morning warm-up command (if and when applicable)
- Override commands for outputs 3, 4 and 5 (if and when applicable)
- Outside temperature

NOTE: If a slave is not on the Master's list, these data transactions are NOT made with that slave.

Positioning the Master on a network

The Master unit can be placed at any point on a bus, while still respecting a bus topology. Even though the diagrams shown in the «Typical Network Configurations » section always depict the Master at either end of a bus, it can also be placed in between two slave VC1000s. Note that the computer must always communicate to the network through the Master and therefore must still be directly connected to it.

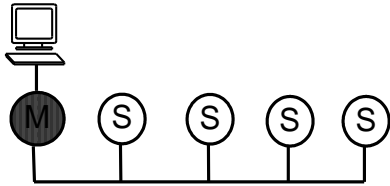

Correct

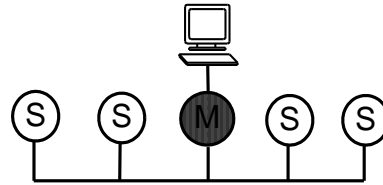

Also correct

Typical Network Configurations

Configuration 1: RS485 Direct connection to multiple slaves

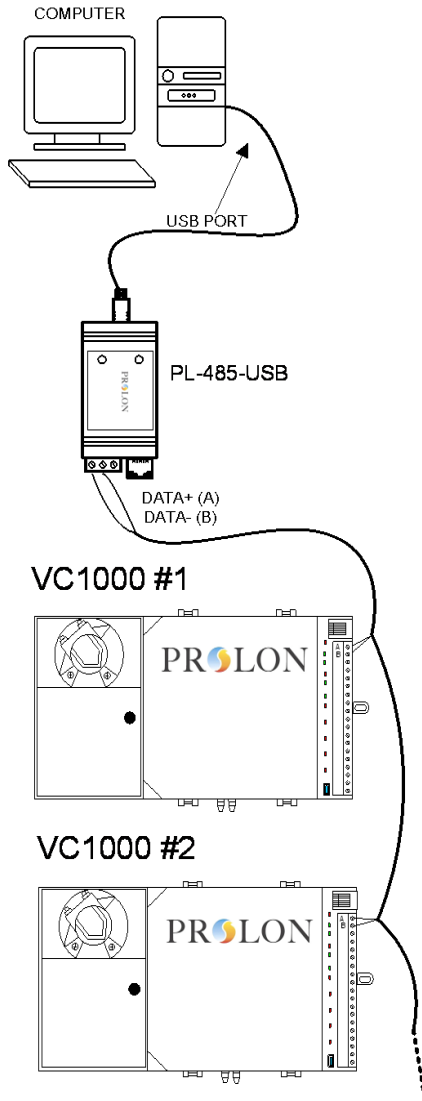

1. Connect the PL-485-USB to the computer.
2. Connect the (+) and (-) pins of the PL-485-USB to the A and B ports of the first VC1000 Slave respectively.
3. Connect all subsequent A ports together and then B ports together in standard bus topology.
4. In a RS485 network, the first and last device in the chain must have its terminating resistor enabled. In this case, the first device is the PL-485-USB and the last device is the last Slave in the daisy chain. All other devices have their terminating resistor disabled. (See the [Terminating resistors](#) section for more details)
5. In a RS485 network, a single device in the chain must have its bias resistor enabled. In this case, the PL-485-USB already has its bias resistor enabled (already installed by default) so it must be disabled for all the VC1000s on the network. (See the [Bias Resistors](#) section for more details)
6. Finally, you must connect one end of the shield to a protective ground. Please remember that all devices on an RS485 network must share the same [common](#).

Configuration 2: Internet connection to multiple slaves

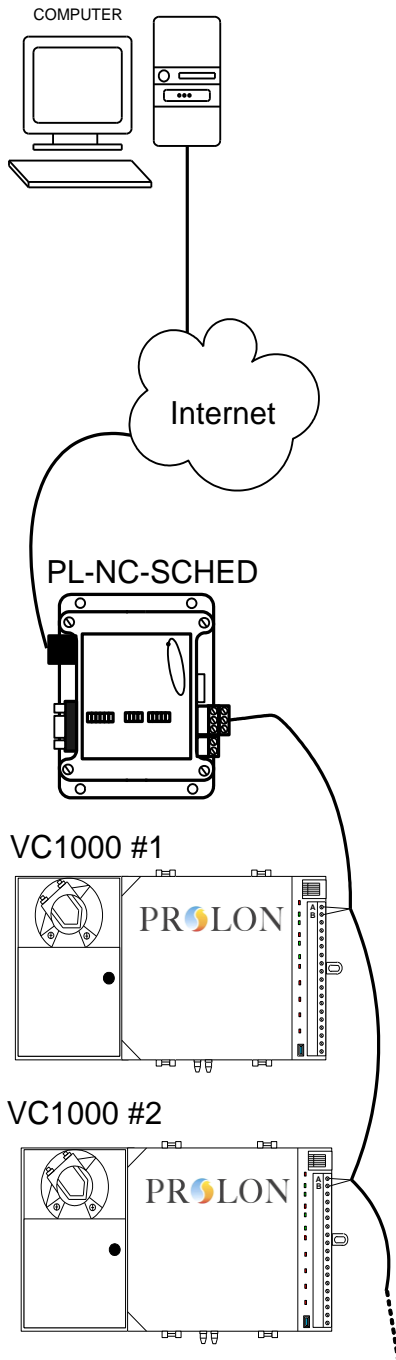

1. For proper communication between your computer and the VC1000 devices, an active Internet connection must be established and running on your computer. Make sure the computer is properly connected to the Internet.

2. Make sure your PL-NC-SCHED is properly configured. (See the [PL-NC-SCHED](#) section for more details)

3. Connect the (+) and (-) pins of the PL-NC-SCHED to the A and B ports of the first VC1000 Slave respectively. (See the [PL-NC-SCHED](#) section for more details)

4. Connect all subsequent A ports together and then B ports together in standard bus topology.

5. In a RS485 network, the first and last device in the chain must have its terminating resistor enabled. In this case, the first device is the PL-NC-SCHED and the last device is the last Slave in the daisy chain. All other devices have their terminating resistor disabled. (See the [Terminating Resistors](#) section for more details)

6. In a RS485 network, a single device in the chain must have its bias resistor enabled. (See the [Bias Resistors](#) section for more details)

7. Finally, you must connect one end of the shield to a protective ground. Please remember that all devices on an RS485 network must share the same [common](#).

Configuration 3: Modem connection to multiple slaves

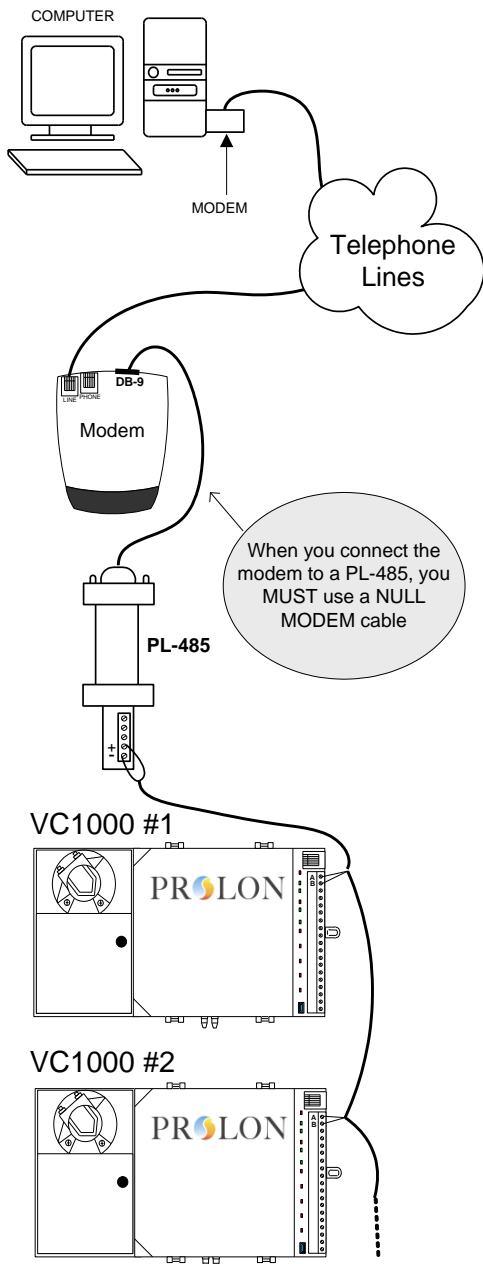

1. Make sure the modem on your computer is connected to the telephone line. ProLon Focus will automatically configure the modem for you.

2. On the receiving end of the connection (the VC1000s location), make sure that the modem is connected to a telephone line. An RJ11 cable should run from the wall jack directly to the LINE port on your modem. Make sure the receiving modem is properly configured (see the [Modem](#) section for more details)

3. Connect the receiving modem's RS232 serial port to the PL-485-USB (DB-9 connections) using a NULL MODEM cable or connector.

4. Connect the (+) and (-) pins of the PL-485-USB to the A and B ports of the first VC1000 Slave respectively.

5. Connect all subsequent A ports together and then B ports together in standard bus topology. (see the [Topology](#) section for more details)

6. In a RS485 network, the first and last device in the chain must have its terminating resistor enabled. In this case, the first device is the PL-485-USB and the last device is the last Slave in the daisy chain. All other devices have their terminating resistor disabled. (see the [Terminating Resistors](#) section for more details)

7. In a RS485 network, a single device in the chain must have its bias resistor enabled. In this case, the PL-485-USB already has its bias resistor enabled (already installed by default) so it must be disabled for all the VC1000s on the network. (see the [Bias Resistors](#) section for more details)

8. Finally, you must connect one end of the shield to a protective ground. Please remember that all devices on an RS485 network must share the same [common](#).

Configuration 4: RS485 Direct connection with a single Master and multiple slaves

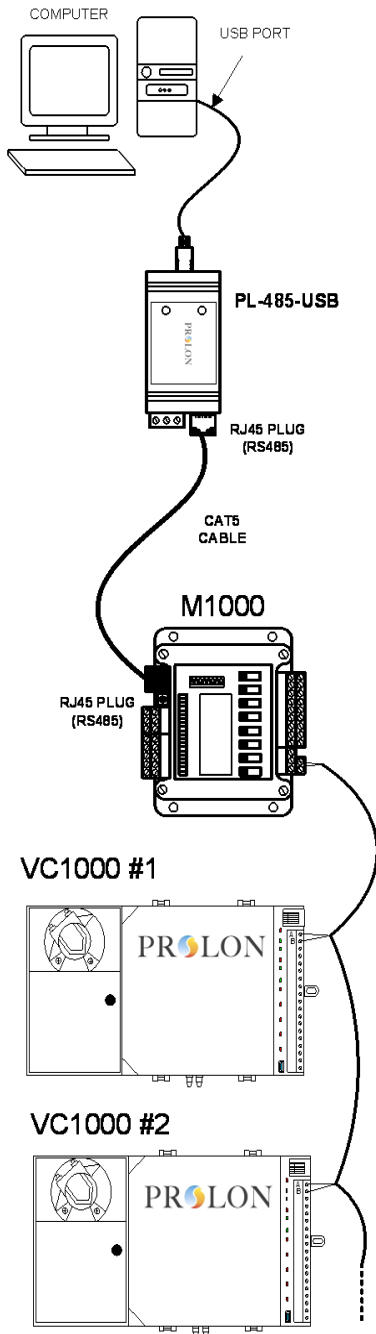

1. Connect the PL-485-USB to the computer.

2. Normally the PL-485-USB is sold with a PL-BR2. The PL-BR2 converts the A and B wires of the PL-485-USB into an RJ45 female port. This allows for easy connection to the ProLon Master device's RJ45 port by a standard Internet cable (CAT5).

*** If you do not have a PL-BR2, then you can directly connect a PL-485-USB to a Master by creating the proper male RJ45 connection. (see the [PL-BR2](#) section for more details)

3. Once the Master is connected to the PL-BR2, you must connect the Master device to the first Slave device in the daisy chain. To do so, the Master device's NET A port must be directly connected to the NET A port of the first Slave device. The same must be done for the NET B wires.

4. All Slaves must all be connected in a daisy-chain configuration. Connect all subsequent A ports together and then B ports together in standard bus topology. (see the [Topology](#) section for more details)

5. In a RS485 network, the first and last device in a chain must have its terminating resistor enabled (see the [Terminating Resistors](#) section for more details). In this case, there are two separate chains; the PL-485-USB to the Master, and the Master to the last Slave device. Therefore, terminating resistors must be enabled at:

- PL-485-USB
- Master RJ45 (already installed by default)
- Master NET A / B (already installed by default)
- Last Slave NET A / B

All other devices must have their terminating resistors disabled.

(See next page for the last steps)

6. In a RS485 network, a single device in the chain must have its bias resistor enabled. In this case, the Master must have its bias resistor enabled (already installed by default) and all slaves must have their bias resistors disabled. (See the [Bias Resistors](#) section for more details)

7. Finally, you must connect one end of the shield of each separate bus to a protective ground. Please remember that all devices on an RS485 network must share the same [common](#).

Configuration 5: Internet connection with a single Master and multiple slaves

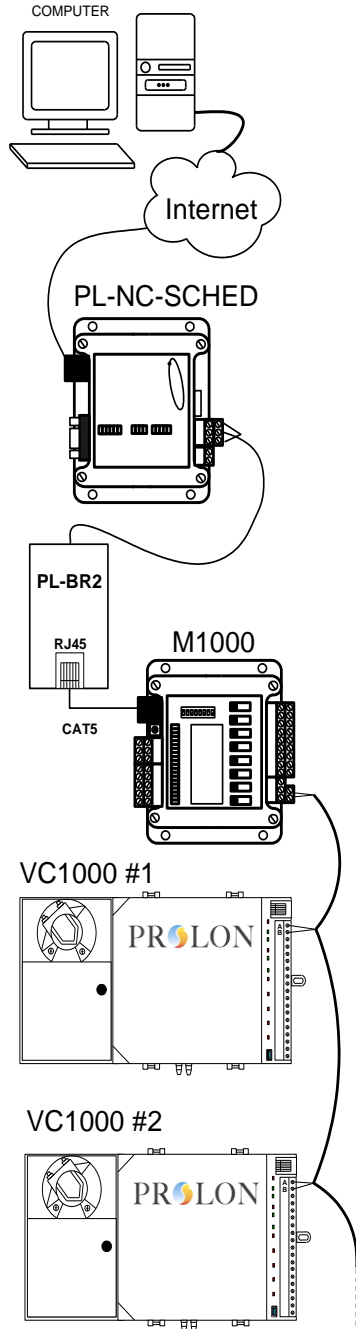

1. For proper communication between your computer and the VC1000 devices, an active Internet connection must be established and running on your computer. Make sure the computer is properly connected to the Internet.

2. Make sure your PL-NC-SCHED is properly configured. (see the [PL-NC-SCHED](#) section for more details)

3. Normally the PL-NC-SCHED is sold with a PL-BR2. The PL-BR2 converts the A and B wires of the PL-NC-SCHED into an RJ45 female port. This allows for easy connection to the ProLon Master unit's RJ45 port by a standard Internet cable (CAT5).

*** If you do not have a PL-BR2, then you can directly connect a PL-NC-SCHED to a Master by creating the proper male RJ45 connection. (see the [PL-BR2](#) section for more details)

4. Once the PL-NC-SCHED is properly connected to the Master device, you must connect the Master device to the first Slave device in the daisy chain. To do so, the Master device's NET A port must be directly connected to the NET A port of the first Slave device. The same must be done for the NET B wires.

5. For the Slave devices, connect all subsequent A ports together and then B ports together in standard bus topology. (see the [Topology](#) section for more details)

6. In a RS485 network, the first and last device in a chain must have its terminating resistor enabled (see the [Terminating Resistors](#) section for more details). In this case, there are two separate chains; the PL-NC-SCHED to the Master, and the Master to the last Slave device. Therefore, terminating resistors must be enabled at:

- PL-NC-SCHED
- Master RJ45 (already installed by default)
- Master NET A / B (already installed by default)
- Last Slave NET A / B

All other devices must have their terminating resistors disabled.

7. In a RS485 network, a single device in the chain must have its bias resistor enabled. In this case, the Master must have its bias resistors enabled on both ports (already installed by default) and all slaves must have their bias resistor disabled. (See the [Bias Resistors](#) section for more details)

8. Finally, you must connect one end of the shield of each separate bus to a protective ground. Please remember that all devices on an RS485 network must share the same [common](#).

Configuration 6: Modem connection with a single Master and multiple slaves

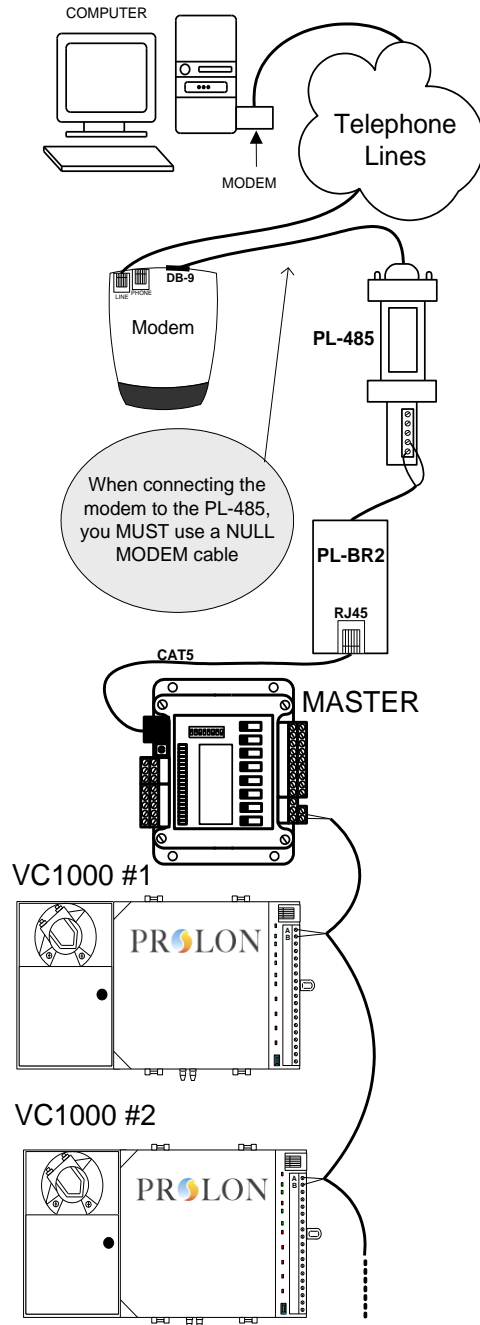

1. Make sure the modem on your computer is connected to a telephone line. ProLon Focus will automatically configure the modem for you.

2. On the receiving end of the connection (the VC1000s location), make sure that the modem is connected to the telephone line. An RJ11 wire should run from the wall jack directly to the LINE port on the receiving modem. Make sure this modem is properly configured. (see the [Modem](#) section for more details)

3. Connect the receiving modem's RS232 serial port to the PL-485 (DB-9 connection) using a NULL MODEM cable or connector. Make sure your PL-485 is properly configured. (see the [Modem](#) section for more details)

4. Normally the PL-485-USB is sold with a PL-BR2. The PL-BR2 converts the A and B wires of the PL-485 into an RJ45 female port. This allows for easy connection to the VC1000 Master device's RJ45 port by a standard Internet cable (CAT5).

*** If you do not have a PL-BR2, then you can directly connect a PL-485 to a Master by creating the proper male RJ45 connection. (see the [PL-BR2](#) section for more details).

5. Once the PL-BR2 is connected to the Master device, you must connect the Master device to the first Slave device in the daisy chain. To do so, the Master device's NET A port must be directly connected to the NET A port of the first Slave device. The same must be done for the NET B wires.

6. For the Slave devices, connect all subsequent A ports together and then B ports together in standard bus topology. (see the [Topology](#) section for more details)

7. In a RS485 network, the first and last device in a chain must have its terminating resistor enabled (see the [Terminating Resistors](#) section for more details). In this case, there are two separate chains; the PL-485-USB to the Master, and the Master to the last Slave device. Therefore, terminating resistors must be enabled at:

- PL-485-USB
- Master RJ45 (already installed by default)
- Master NET A / B (already installed by default)
- Last Slave NET A / B

All other devices must have their terminating resistor disabled.

8. In a RS485 network, a single device in the chain must have its bias resistor enabled. (See the [Bias Resistors](#) section for more details) In this case, the Master must have its bias resistors enabled on both ports (already installed by default) and all slaves must have their bias resistors disabled.

9. Finally, you must connect one end of the shield of each separate bus to a protective ground. Please remember that all devices on an RS485 network must share the same [common](#).

Configuration 7: RS485 Direct connection with multiple Masters and multiple slaves

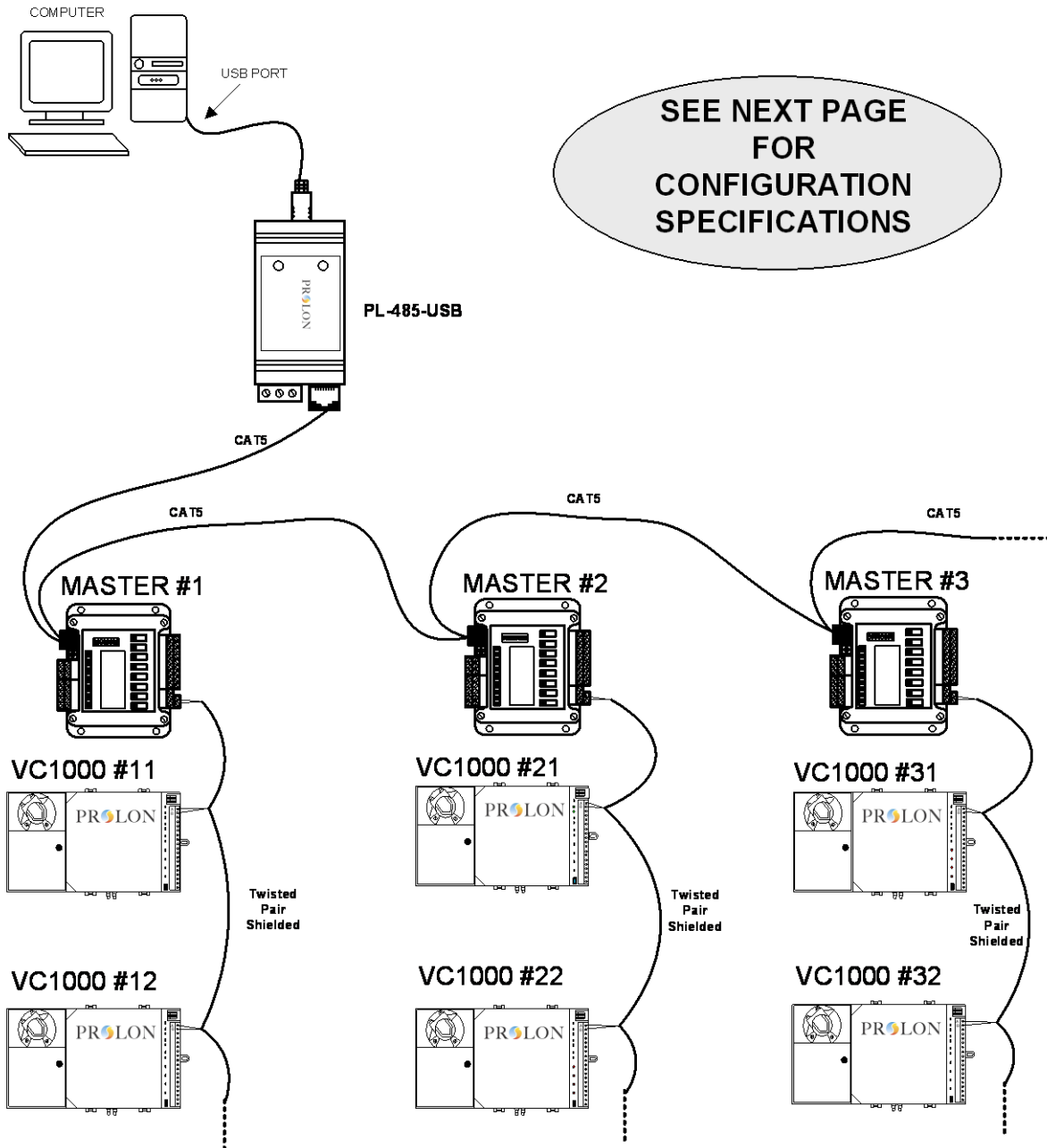

*** This configuration corresponds to the network displayed in the diagram on the preceding page. Even though the diagram shows an RS-485 Direct connection, Modem and Internet connections are also applicable here.

1. Connect the PL-BR2 to the first Master device's RJ45 port (either RJ45 port is valid since they are both connected in parallel). The other RJ45 port on the first Master connects to the RJ45 port on the following Master.

2. Once all Masters are connected, you must connect each individual Master to the first Slave in its sub-network. To do so, the Master device's NET A port must be directly connected to the NET A port of the first Slave device. The same must be done for the NET B wires.

3. All Slaves sharing the same Master must then all be connected in a daisy-chain configuration: connect all subsequent A ports together and then B ports together in standard bus topology. (see the [Topology](#) section for more details)

4. For each Master device present on the network, repeat steps 3 and 4. NOTE: Every device on the network must have a different address, even if they don't belong to the same master. The addresses shown here were chosen for clarity only.

5. In a RS485 network, the first and last device in a chain must have its terminating resistor enabled (see the [Terminating Resistors](#) section for more details). In this case, there are two separate types of chains; the chain from the PL-485-USB to the last Master, and the chains from each Master to their corresponding Slaves. Therefore, terminating resistors must be enabled at:

- PL-485-USB
- The last Master RJ45 port (already installed by default)
- Each Master NET A/B port (already installed by default)
- Each last Slave NET A/B port.

All remaining ports on other devices must have their terminating resistor disabled.

6. In a RS485 network, a single device in the chain must have its bias resistor enabled (See the [Bias Resistors](#) for more details). In this case, each Master must have its bias resistor for the NET A/B port enabled (already installed by default) and all its slaves must have their bias resistor disabled. Only one device on the RJ45 chain must have its bias resistors enabled.

7. Finally, you must connect one end of the shield of each separate bus to a protective ground. Please remember that all devices on an RS485 network must share the same [common](#).

Network Components

PL-485

There are two models of the PL-485; one that can be used on your computer's RS-232 port (if available), and one that can be used on a USB port:

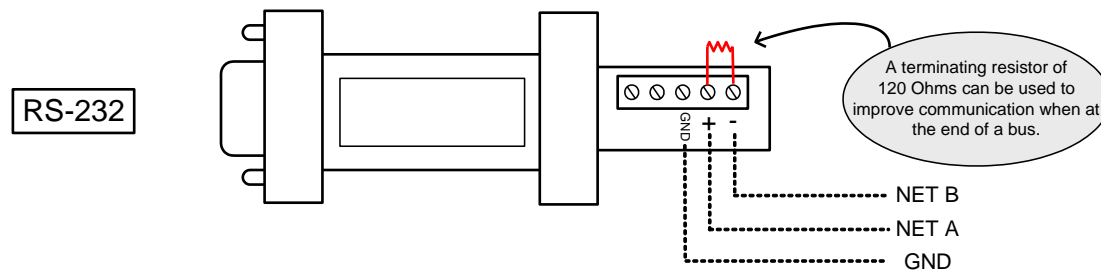

The PL-485-USB is an RS-485 bidirectional converter. It is used to allow a computer or modem to communicate properly with the VC1000 system.

Since the PL-485 usually marks the beginning of a RS-485 network, it is recommended to put a terminating resistor (120Ω) between the positive and negative pins.

The PL-485 is a port-powered device (power is received from the computer), therefore it does not require any additional power source. However, if it is being powered by a laptop that is currently losing its charge, the performance of the PL-485 may be compromised.

For the RS-232 model, a DB9 male to female cable may be required to connect the PL-485, in case there is not enough room around the RS-232 port on your PC.

For the USB model, note that there is an RJ45 plug and a 3 screw connector. Both of these are in parallel and are simply there to facilitate the physical connection to the system. They are not separate ports.

PL-NC-SCHED

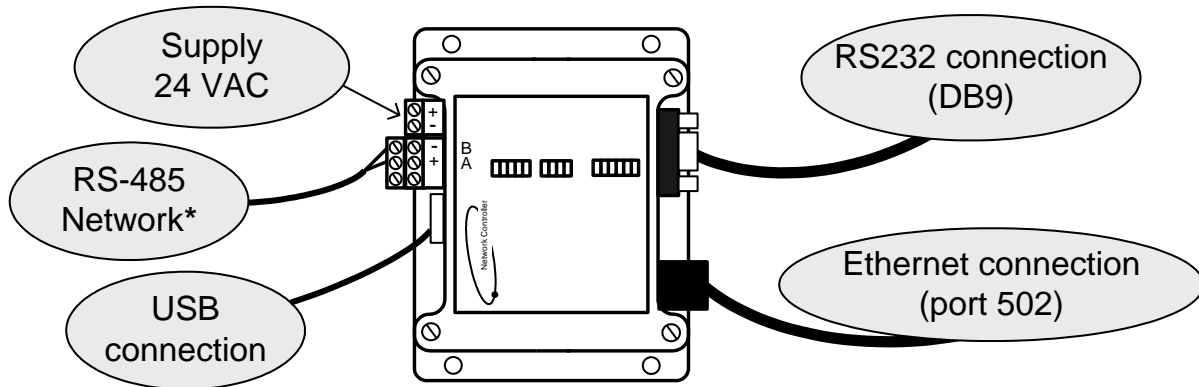

* A terminating resistor is already factory installed, but should be removed when this device is not at one of the extremities of the RS485 bus.

Default IP Settings	
IP Address:	192.168.1.99
Subnet Mask:	255.255.255.0
Default Gateway:	192.168.1.1

Default Modbus Address: 99

The PL-NC-SCHED has two main functions. The first is to act as an Ethernet to RS485 converter, used to convert the Modbus TCP/IP protocol into Modbus RTU serial protocol, allowing a user to view his whole ProLon zoning system from the internet. Its second function is to provide scheduling information to any device on the ProLon zoning system.

The ProLon Focus software communicates with the PL-NC-SCHED over Ethernet through the Modbus-specified **TCP port 502**.

For a local network setup, the only configuration usually required is to make sure the IP Settings are adjusted in the PL-NC-SCHED so that it resides on the same subnet as your local network. The default IP settings are shown above. The PL-NC-SCHED can also be configured for DHCP.

To access the PL-NC-SCHED externally, the general procedure is as follows:

- Setup Port-Forwarding in your router to direct TCP communications coming from port 502 towards the PL-NC-SCHEDs IP address
- Setup a fixed IP address that can be used to allow the ProLon Focus software to externally connect to the PL-NC-SCHED through your router. This is usually done in one of the two following ways:
 1. Obtain a static IP address from your ISP provider
 2. Subscribe to a Dynamic DNS service such as DynDNS and configure your router accordingly

At all times, you can directly connect and configure the PL-NC-SCHED through the USB or RS232 port.

The PL-NC-SCHED has a single RS485 port made accessible through two parallel connectors. It is through this port that communication to the rest of the ProLon zoning system is established. A factory installed terminating resistor is in place for the RS485 network, however the PL-NC-SCHED does not have BIAS resistors, so they will have to be enabled on another device from the network.

MODEM

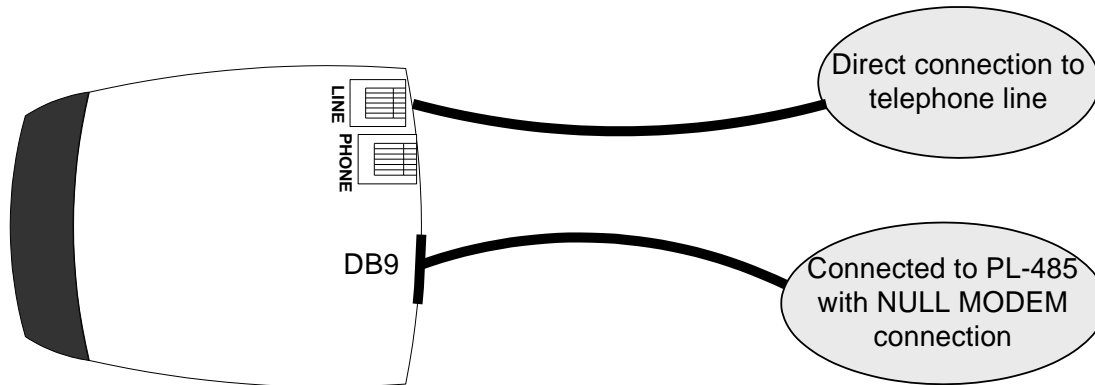

To connect to a VC1000 network from a computer over a phone line, your computer must first be equipped with a modem. If you are using ProLon Focus, Focus automatically configures the modem for you. Otherwise, you must determine the proper configuration for your software.

On the receiving end (at the location of the VC1000s themselves, any modem can be used, as long as it complies with at least one of the following norms:

- V.34
- V.42bis
- V.44

The modem must then be set to Auto-Answer mode. If this is not already done, you can do so by connecting the modem to a COM port on a PC and opening HyperTerminal to the following settings:

- Baud rate: 57600 bps
- Data bits: 8
- Parity: None
- Stop Bits: 1
- Flow Control: None

You must then input the following command (press Enter to send the command):

“ATS0=1 &W &Y”

“ATE0 &W &Y”

(In both commands, the symbol after ‘ATS’ is a zero and not the letter O)

This will enable the modem to answer the phone after the FIRST ring, with echo OFF, and to save this configuration to memory. If you wish the modem to answer after a higher ring count, replace the number “1” with the desired amount of rings.

The modem is then connected to a PL-485 by its DB9 port. Note that for a modem connection, the modem must be connected to the PL-485 using a NULL MODEM cable or connector.

PL-BR2

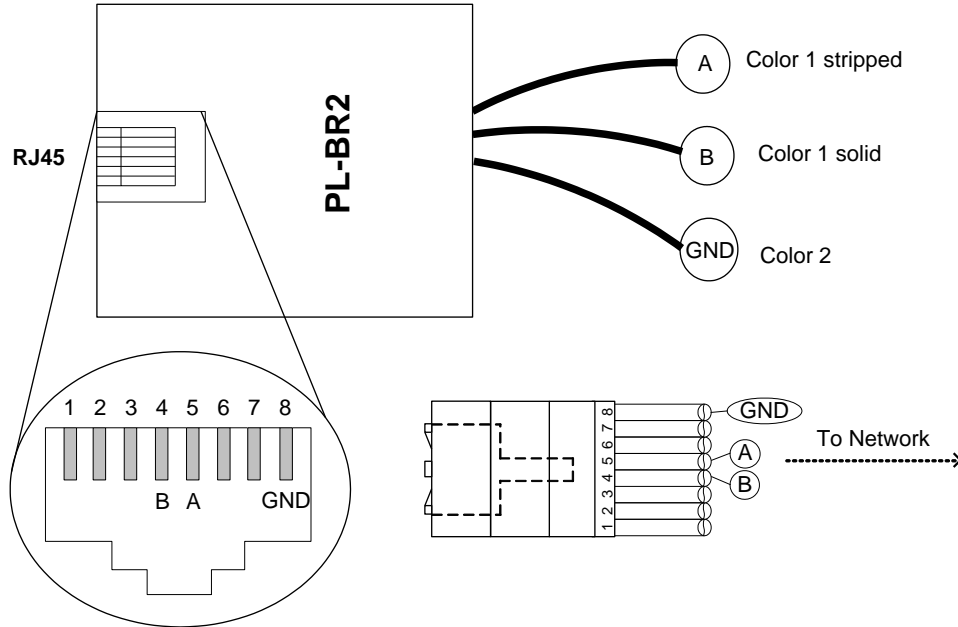

The PL-BR2 is a simple tool that converts the NET A, B and GND wires from an RS485 system into a female RJ45 port. The alignment of the wires in the RJ45 port corresponds to the official Modbus protocol. All ProLon devices also follow this protocol for their RJ45 ports. The main purpose of this device is to allow you to use a simple, unmodified Ethernet cable (CAT5) to connect two RS485 ProLon nodes together.

NET	Wire Color
A	Color 1 striped
B	Color 1 solid
GND	Color 2

© Copyright 2014 ProLon. All rights reserved.

No part of this document may be photocopied or reproduced by any means, or translated to another language without prior written consent of ProLon.

All specifications are nominal and may change as design improvements are introduced. ProLon shall not be liable for damages resulting from misapplication or misuse of its products.

All trademarks are the property of their respective owners.